



## INSTRUCTION MANUAL

# VHF MARINE TRANSCEIVER IC-M302



Icom Inc.

---

## FOREWORD

---

Thank you for purchasing this Icom product. The IC-M302 VHF MARINE TRANSCEIVER is designed and built with Icom's state of the art technology and craftsmanship. With proper care, this product should provide you with years of trouble-free operation.

We want to take a couple of moments of your time to thank you for making the IC-M302 your radio of choice, and hope you agree with Icom's philosophy of "technology first." Many hours of research and development went into the design of your IC-M302.

### ◇ **FEATURES**

- *Large 2-digit Ch with scrolling channel comment*
- *Easy to hear speaker*
- *Built-in DSC meets RTCM SC101 requirement*
- *Rugged waterproof construction*

Icom, Icom Inc. and the ICOM logo are registered trademarks of Icom Incorporated (Japan) in the United States, the United Kingdom, Germany, France, Spain, Russia and/or other countries.

---

## IMPORTANT

---

**READ ALL INSTRUCTIONS** carefully and completely before using the transceiver.

**SAVE THIS INSTRUCTION MANUAL** — This instruction manual contains important operating instructions for the IC-M302.

---

## EXPLICIT DEFINITIONS

---

WORD	DEFINITION
⚠ <b>WARNING!</b>	Personal injury, fire hazard or electric shock may occur.
<b>CAUTION</b>	Equipment damage may occur.
<b>NOTE</b>	Recommended for optimum use. No risk of personal injury, fire or electric shock.

**CLEAN THE TRANSCEIVER AND MICROPHONE THOROUGHLY WITH FRESH WATER** after exposure to water including salt water, otherwise, the keys and switches may become inoperable due to salt crystallization.

---

## IN CASE OF EMERGENCY

---

If your vessel requires assistance, contact other vessels and the Coast Guard by sending a distress call on Channel 16.

### **USING CHANNEL 16**

#### **DISTRESS CALL PROCEDURE**

1. "MAYDAY MAYDAY MAYDAY."
2. "THIS IS ....." (name of vessel)
3. Your call sign or other indication of the vessel (AND 9-digit DSC ID if you have one).
4. "LOCATED AT ....." (your position)
5. The nature of the distress and assistance required.
6. Any other information which might facilitate the rescue.

Or, transmit your distress call using digital selective calling on Channel 70.

### **USING DIGITAL SELECTIVE CALLING (Ch 70)**

#### **DISTRESS CALL PROCEDURE**

1. While lifting up the key cover, push and hold **[DISTRESS]** for 5 sec. until you hear 5 short beeps change to one long beep.
2. Wait for an acknowledgment on Channel 70 from a coast station.
  - After the acknowledgment is received, Channel 16 is automatically selected.
3. Push and hold **[PTT]**, then transmit the appropriate information as listed above.

---

## NOTE

---

**A WARNING STICKER** is supplied with the transceiver. To comply with FCC regulations, this sticker must be affixed in such a location as to be readily seen from the operating controls of the radio as in the diagram below. Make sure the chosen location is clean and dry before applying the sticker. (p. 31)

### EXAMPLE

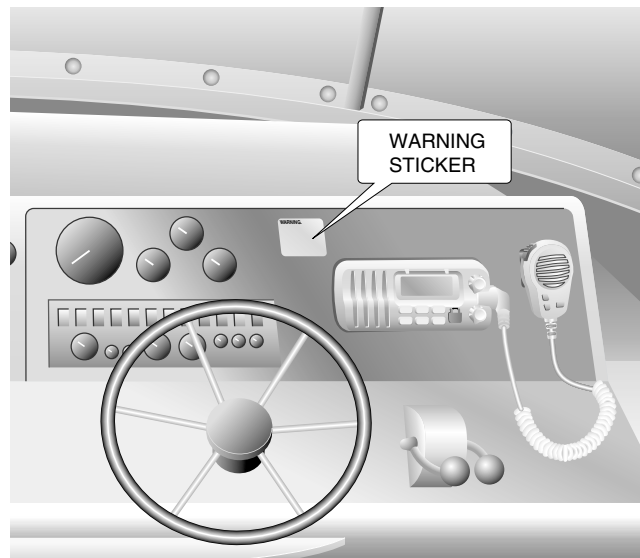

---

## RADIO OPERATOR WARNING

---



Icom requires the radio operator to meet the FCC Requirements for Radio Frequency Exposure. An omnidirectional antenna with gain not greater than 9 dBi must be mounted a minimum of 5 meters (measured from the lowest point of the antenna) vertically above the main deck and

all possible personnel. This is the minimum safe separation distance estimated to meet all RF exposure compliance requirements. This 5 meter distance is based on the FCC Safe Maximum Permissible Exposure (MPE) distance of 3 meters added to the height of an adult (2 meters) and is appropriate for all vessels.

For watercraft without suitable structures, the antenna must be mounted so as to maintain a minimum of 1 meter vertically between the antenna, (measured from the lowest point of the antenna), to the heads of all persons AND all persons must stay outside of the 3 meter MPE radius.

Do not transmit with radio and antenna when persons are within the MPE radius of the antenna, unless such persons (such as driver or radio operator) are shielded from antenna field by a grounded metallic barrier. The MPE Radius is the minimum distance from the antenna axis that person should maintain in order to avoid RF exposure higher than the allowable MPE level set by FCC.

**FAILURE TO OBSERVE THESE LIMITS MAY ALLOW THOSE WITHIN THE MPE RADIUS TO EXPERIENCE RF RADIATION ABSORPTION WHICH EXCEEDS THE FCC MAXIMUM PERMISSIBLE EXPOSURE (MPE) LIMIT. IT IS THE RESPONSIBILITY OF THE RADIO OPERATOR TO ENSURE THAT THE MAXIMUM PERMISSIBLE EXPOSURE LIMITS ARE OBSERVED AT ALL TIMES DURING RADIO TRANSMISSION. THE RADIO OPERATOR IS TO ENSURE THAT NO BYSTANDERS COME WITHIN THE RADIUS OF THE MAXIMUM PERMISSIBLE EXPOSURE LIMITS.**

### **Determining MPE Radius**

**THE MAXIMUM PERMISSIBLE EXPOSURE (MPE) RADIUS HAS BEEN ESTIMATED TO BE A RADIUS OF ABOUT 3M PER OET BULLETIN 65 OF THE FCC. THIS ESTIMATE IS MADE ASSUMING THE MAXIMUM POWER OF THE RADIO AND ANTENNAS WITH A MAXIMUM GAIN OF 9dBi ARE USED FOR A SHIP MOUNTED SYSTEM.**

---

# TABLE OF CONTENTS

---

FOREWORD .....	i	<b>5 SCAN OPERATION .....</b>	<b>12–13</b>	<b>9 TROUBLESHOOTING .....</b>	<b>35</b>
IMPORTANT .....	i	■ Scan types .....	12	<b>10 CHANNEL LIST .....</b>	<b>36</b>
EXPLICIT DEFINITIONS .....	i	■ Setting tag channels .....	13	<b>11 SPECIFICATIONS .....</b>	<b>37–38</b>
IN CASE OF EMERGENCY .....	ii	■ Starting a scan .....	13	■ Specifications .....	37
NOTE .....	ii	<b>6 DSC OPERATION .....</b>	<b>14–27</b>	■ Dimensions .....	38
RADIO OPERATOR WARNING .....	iii	■ MMSI code programming .....	14	<b>12 MB-69 TEMPLATE .....</b>	<b>39</b>
TABLE OF CONTENTS .....	iv	■ MMSI code check .....	14	<b>13 OPTIONS .....</b>	<b>41</b>
PRECAUTION .....	v	■ DSC individual ID .....	15		
<b>1 OPERATING RULES .....</b>	<b>1</b>	■ Position indication .....	16		
<b>2 PANEL DESCRIPTION .....</b>	<b>2–5</b>	■ Distress call .....	17		
■ Front panel .....	2	■ Transmitting DSC calls .....	18		
■ Function display .....	4	■ Receiving DSC calls .....	25		
■ Microphone .....	5	<b>7 SET MODE .....</b>	<b>28–30</b>		
<b>3 BASIC OPERATION .....</b>	<b>6–10</b>	■ SET mode programming .....	28		
■ Channel selection .....	6	■ SET mode items .....	29		
■ Receiving and transmitting .....	8	<b>8 CONNECTIONS AND</b>			
■ Call channel programming .....	9	<b>MAINTENANCE .....</b>	<b>31–34</b>		
■ Channel comments .....	10	■ Supplied accessories .....	31		
■ Microphone lock function .....	10	■ Antenna .....	31		
■ Display backlighting .....	10	■ Fuse replacement .....	31		
<b>4 DUALWATCH/TRI-WATCH .....</b>	<b>11</b>	■ Cleaning .....	31		
■ Description .....	11	■ Connections .....	32		
■ Operation .....	11	■ Mounting the transceiver .....	33		
		■ Optional MB-92 attachment .....	33		
		■ Optional MB-69 installation .....	34		

---

## PRECAUTION

---

**⚠ WARNING! NEVER** connect the transceiver to an AC outlet. This may pose a fire hazard or result in an electric shock.

**CAUTION:** Changes or modifications to this device, not expressly approved by Icom Inc., could void your authority to operate this device under FCC regulations.

**NEVER** connect the transceiver to a power source of more than 16 V DC or use reverse polarity. This will ruin the transceiver.

**NEVER** cut the DC power cable between the DC plug and fuse holder. If an incorrect connection is made after cutting, the transceiver may be damaged.

**NEVER** place the transceiver where normal operation of the vessel may be hindered or where it could cause bodily injury.

**KEEP** the transceiver at least 3.3 ft (1 m) away from the ship's navigation compass.

**DO NOT** use or place the transceiver in areas with temperatures below  $-4^{\circ}\text{F}$  ( $-20^{\circ}\text{C}$ ) or above  $+140^{\circ}\text{F}$  ( $+60^{\circ}\text{C}$ ) or, in areas subject to direct sunlight, such as the dashboard.

**AVOID** the use of chemical agents such as benzine or alcohol when cleaning, as they may damage the transceiver surfaces.

**BE CAREFUL!** The transceiver rear panel will become hot when operating continuously for long periods.

Place the transceiver in a secure place to avoid inadvertent use by children.

**BE CAREFUL!** The transceiver employs waterproof construction, which corresponds to JIS waterproof specification, Grade 7 (1 m/30 min.). However, once the transceiver has been dropped, waterproofing cannot be guaranteed due to the fact that the case may be cracked, or the waterproof seal damaged, etc.

## ◇ PRIORITIES

- Read all rules and regulations pertaining to priorities and keep an up-to-date copy handy. Safety and distress calls take priority over all others.
- You must monitor Channel 16 when you are not operating on another channel.
- False or fraudulent distress signals are prohibited and punishable by law.

## ◇ PRIVACY

- Information overheard but not intended for you cannot lawfully be used in any way.
- Indecent or profane language is prohibited.

## ◇ RADIO LICENSES

### (1) SHIP STATION LICENSE

You must have a current radio station license before using the transceiver. It is unlawful to operate a ship station which is not licensed.

Inquire through your dealer or the appropriate government agency for a Ship-Radiotelephone license application. This government-issued license states the call sign which is your craft's identification for radio purposes.

### (2) OPERATOR'S LICENSE

A Restricted Radiotelephone Operator Permit is the license most often held by small vessel radio operators when a radio is not required for safety purposes.

The Restricted Radiotelephone Operator Permit must be posted or kept with the operator. Only a licensed radio operator may operate a transceiver.

However, non-licensed individuals may talk over a transceiver if a licensed operator starts, supervises, ends the call and makes the necessary log entries.

Keep a copy of the current government rules and regulations handy.

### **Radio license for boaters (U.S.A. only)**

The Telecommunications Act of 1996 permits recreational boaters to have and use a VHF marine radio, EPIRB, and marine radar without having an FCC ship station license. Boaters traveling on international voyages, having an HF single sideband radiotelephone or marine satellite terminal, or required to carry a marine radio under any other regulation must still carry an FCC ship station license. For further information, see the FCC Ship Radio Stations Fact Sheet.

## ■ Front panel

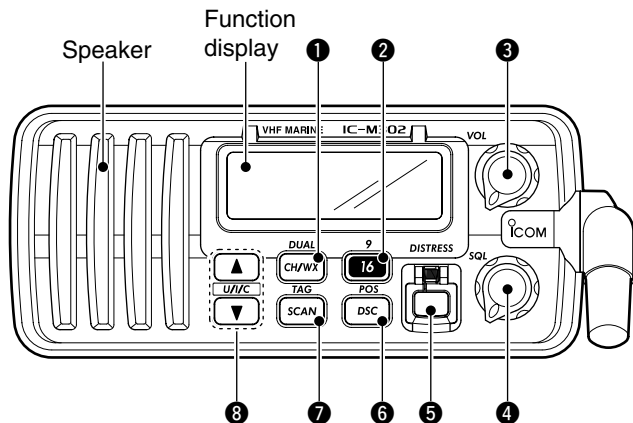

- 1 CHANNEL/WEATHER CHANNEL KEY [CH/WX•DUAL]**
- ➔ Toggles between regular channels and weather channel when pushed momentarily. (p. 7)
  - ➔ Starts Dualwatch or Tri-watch when pushed for 1 sec. (p. 11)
  - ➔ Stops Dualwatch or Tri-watch when either is activated.

- 2 CHANNEL 16/CALL CHANNEL KEY [16•9]**
- ➔ Selects Channel 16 when pushed. (p. 6)
  - ➔ Selects call channel when pushed for 1 sec. (p. 6)
    - “CALL” appears when call channel is selected.
  - ➔ Push for 3 sec. to enter call channel programming condition when call channel is selected. (p. 9)
  - ➔ While pushing [CH/WX•DUAL], push to enter the channel comment programming condition. (p. 10)
  - ➔ Enters Set mode when pushed while turning power ON. (p. 28)
- 3 POWER/VOLUME CONTROL [VOL]**
- Turns power ON and OFF and adjusts the audio level. (p. 8)
- 4 SQUELCH CONTROL [SQL]**
- Sets the squelch threshold level. (p. 8)
- 5 DISTRESS KEY [DISTRESS]**
- Transmits Distress call when pushed for 5 sec. (p. 17)
- 6 DSC/POSITION KEY [DSC•POS]**
- ➔ Selects the DSC menu when pushed. (p. 14)
  - ➔ Shows current position and time from a GPS receiver, when pushed for 1 sec. (p. 16)



**7 SCAN KEY [SCAN•TAG]**

- Starts and stops Normal or Priority scan.
- Sets or clears the displayed channel as a tag (scanned) channel when pushed for 1 sec.
- While pushing [HI/LO] on the microphone, push for 3 sec. to clear or set all tag channels in the selected channel group.

**8 CHANNEL UP/DOWN KEYS [▲]/[▼]•[U/I/C]**

- Selects the operating channels, Set mode settings, etc. (pgs. 6, 7, 28)
- While pushing [SCAN•TAG], push [▲] or [▼] to adjust the brightness of the LCD and key backlight. (p. 10)
- Selects one of 3 regular channels in sequence when both keys are pushed. (p. 7)
  - International, U.S.A. and Canadian channels are available for regular channels.

## 2 PANEL DESCRIPTION

### ■ Function display

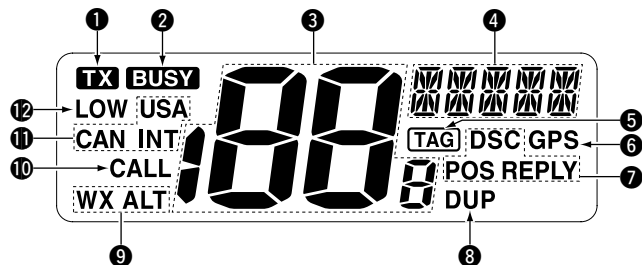

#### 1 TRANSMIT INDICATOR (p. 8)

“TX” appears while transmitting.

#### 2 BUSY INDICATOR (p. 8)

“BUSY” appears when receiving a signal or when the squelch opens.

#### 3 CHANNEL NUMBER READOUT

- ➔ Indicates the selected operating channel number.
  - “A” appears when a simplex channel is selected. “b” appears when a receive only channel for a Canadian channel group is selected. (p. 7)
- ➔ In Set mode, indicates the selected condition. (p. 28)

#### 4 CHANNEL COMMENT INDICATOR

- ➔ Channel comment appears if programmed. (p. 10)
- ➔ “LOW BATTERY” scrolls when the battery voltage drops to approx. 10 V DC or below.
- ➔ “DW” blinks during Dualwatch; “TW” blinks during Tri-watch. (p. 11)

#### 5 TAG CHANNEL INDICATOR (p. 13)

Appears when a tag channel is selected.

#### 6 GPS INDICATOR

- ➔ Appears while valid position data is received.
- ➔ Blinks when invalid position data is received.
- ➔ Disappears when no GPS receiver is connected.

#### 7 DSC INDICATOR

Indicates the DSC status.

- ➔ “DSC” appears when a DSC call is received. (p. 25)
- ➔ “POS REPLY” appears when a Position Request Reply call or Position Report Reply call is received. (p. 27)

#### 8 DUPLEX INDICATOR (p. 7)

Appears when a duplex channel is selected.

#### 9 WEATHER CHANNEL INDICATOR (pgs. 7, 29)

- ➔ “WX” appears when a weather channel is selected.
- ➔ “WX ALT” appears when the Weather alert function is in use; blinks when an alert tone is received.

#### 10 CALL CHANNEL INDICATOR (p. 6)

Appears when the call channel is selected.

#### 11 CHANNEL GROUP INDICATOR (p. 7)

Indicates whether a U.S.A. “USA,” International “INT” or Canadian “CAN” channel is in use.

#### 12 LOW POWER INDICATOR (p. 8)

Appears when low power is selected.

## ■ Microphone

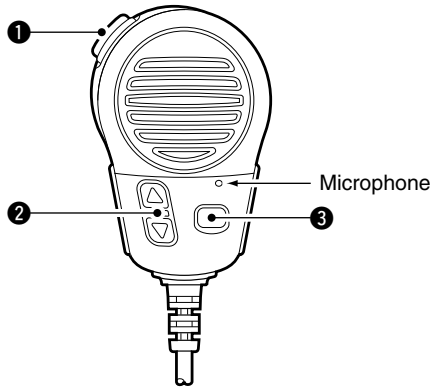

### ❶ PTT SWITCH [PTT]

Push and hold to transmit; release to receive. (p. 8)

### ❷ CHANNEL UP/DOWN KEYS [▲]/[▼]

Push either key to change the operating memory channel, Set mode settings, etc. (pgs. 6, 7, 28)

### ❸ TRANSMIT POWER KEY [HI/LO]

- ➔ Toggles power high and lower when pushed. (p. 8)
  - Some channels are set to low power only.
- ➔ While pushing [HI/LO], turn power ON to toggle the microphone lock function ON and OFF. (p. 10)

## ■ Channel selection

### ◇ Channel 16

Channel 16 is the distress and safety channel. It is used for establishing initial contact with another station and for emergency communications. Channel 16 is monitored during both Dualwatch and Tri-watch. While standing by, you must monitor Channel 16.

- Push **[16•9]** momentarily to select Channel 16.
- Push **[CH/WX•DUAL]** to return to the condition before selecting Channel 16, or push **[▲]** or **[▼]** to select operating channel.

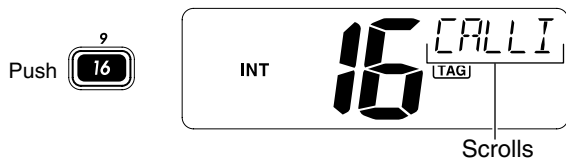

### ◇ Channel 9 (Call channel)

Each regular channel group has a separate leisure-use call channel. The call channel is monitored during Tri-watch. The call channels can be programmed (p. 9) and are used to store your most often used channels in each channel group for quick recall.

- Push **[16•9]** for 1 sec. to select the call channel of the selected channel group.
  - “CALL” and call channel number appear.
  - Each channel group may have an independent call channel after programming a call channel. (p. 9)
- Push **[CH/WX•DUAL]** to return to the condition before selecting call channel, or push **[▲]** or **[▼]** to select an operating channel.

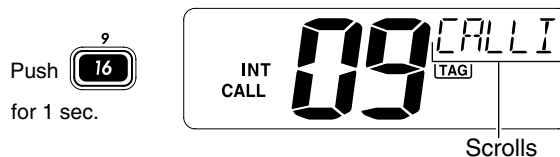

◆ U.S.A., Canadian and international channels

There are 57 U.S.A., 61 Canadian and 57 international channels. These channel groups may be specified for the operating area.

- ① Push [CH/WX•DUAL] to select a regular channel.
  - If a weather channel appears, push [CH/WX•DUAL] again.
- ② Push both [▲] and [▼] on the transceiver to change the channel group, if necessary.
  - U.S.A., International and Canadian channels can be selected in sequence.
- ③ Push [▲] or [▼] to select a channel.
  - “DUP” appears for duplex channels.
  - “R” appears when a simplex channel is selected. “b” appears when a receive only channel for a Canadian channel group is selected.

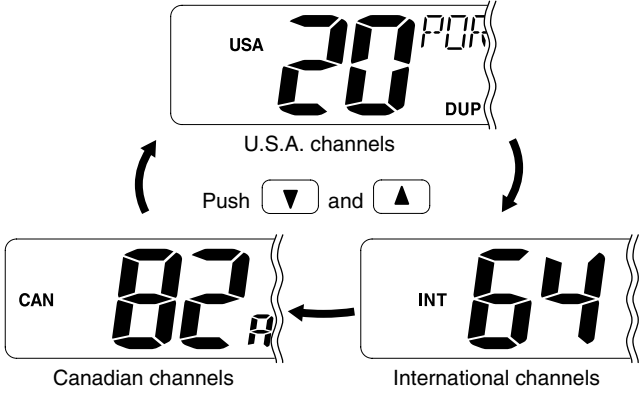

◆ Weather channels

There are 10 weather channels. These are used for monitoring broadcasts from NOAA (National Oceanographic and Atmospheric Administration.)

The transceiver can detect a weather alert tone on the selected weather channel while receiving the channel, during standby on a regular channel or while scanning. (p. 29)

- ① Push [CH/WX•DUAL] once or twice to select a weather channel.
  - “WX” appears when a weather channel is selected.
  - “WX ALT” appears when the Weather alert function is in use. (p. 29)

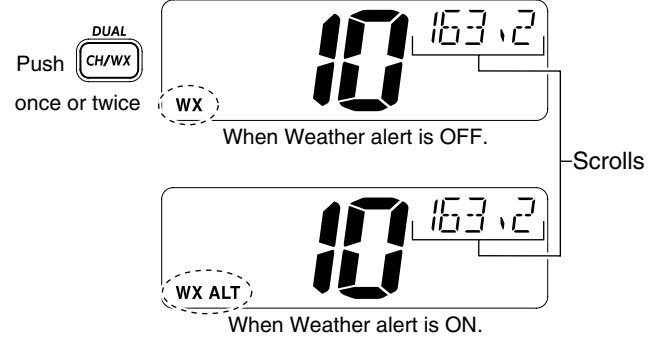

- ② Push [▲] or [▼] to select a channel.

### 3 BASIC OPERATION

## ■ Receiving and transmitting

**CAUTION:** Transmitting without an antenna may damage the transceiver.

- ① Rotate **[VOL]** to turn power ON.
- ② Set the audio and squelch levels.
  - ➔ Rotate **[SQL]** fully counterclockwise in advance.
  - ➔ Rotate **[VOL]** to adjust the audio output level.
  - ➔ Rotate **[SQL]** clockwise until the noise disappears.
- ③ To change the channel group, push both **[▲]** and **[▼]** on the transceiver. (p. 7)
- ④ Push **[▲]** or **[▼]** to select the desired channel. (p. 6)
  - When receiving a signal, “**BUSY**” appears and audio is emitted from the speaker.
  - Further adjustment of **[VOL]** may be necessary.
- ⑤ Push **[HI/LO]** on the microphone to select the output power if necessary.
  - “**LOW**” appears when low power is selected.
  - Choose low power for short range communications, choose high power for longer distance communications.
  - Some channels are for low power only.
- ⑥ Push and hold **[PTT]** to transmit, then speak into the microphone (\*).
  - “**TX**” appears.
  - Channel 70 cannot be used for transmission other than DSC.
- ⑦ Release **[PTT]** to receive.

Simplex channels, 3, 21, 23, 61, 64, 81, 82 and 83 **CANNOT** be lawfully used by the general public in U.S.A. waters.

**IMPORTANT:** To maximize the readability of your transmitted signal, pause a few sec. after pushing **[PTT]**, hold the microphone 2 to 4 inches (5 to 10 cm) from your mouth and speak into the microphone (\*) at a normal voice level.

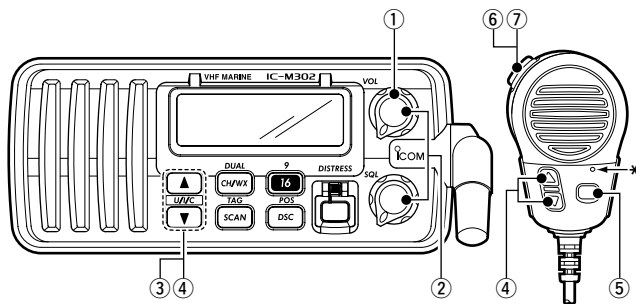

\*: Microphone

## ■ Call channel programming

Call channel is used to select Channel 9 (default), however, you can program the call channel with your most often-used channels in each channel group for quick recall.

- ① Push both [▲] and [▼] on the transceiver one or more times to select the desired channel group (U.S.A., International or Canada) to be programmed.
- ② Push [16•9] for 1 sec. to select the call channel of the selected channel group.
  - “CALL” and call channel number appear.
- ③ Push [16•9] again for 3 sec. (until a long beep changes to 2 short beeps) to enter call channel programming condition.
  - Channel number starts blinking.
- ④ Push [▲] or [▼] to select the desired channel.

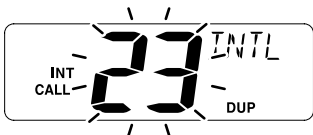

- ⑤ Push [16•9] to program the displayed channel as the call channel.
  - Push [CH/WX•DUAL] to cancel.
  - The channel number stops blinking.

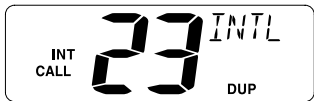

### 3 BASIC OPERATION

## ■ Channel comments

Memory channels can be labeled with alphanumeric comments of up to 10 characters each.

More than 6 characters comment scrolls automatically at the channel comment indicator after the channel selection.

Capital letters, small letters (except f, j, p, s, y, x, z), 0 to 9, some symbols (= \* + - . /) and space can be used.

- ① Select the desired channel.
  - Cancel Dualwatch, Tri-watch or Scan in advance.
- ② While pushing **[CH/WX•DUAL]**, push **[16•9]** to edit the channel comment.
  - A cursor and the first character start blinking alternately.
- ③ Select the desired character by pushing **[▲]** or **[▼]**.
  - Push **[16•9]** or **[CH/WX•DUAL]** to move the cursor forward or backward, respectively.
- ④ Repeat step ③ to input all characters.
- ⑤ Push **[DSC•POS]** to input and set the comment.
  - Push **[CH/WX•DUAL]** to cancel.
  - A cursor and the character stop blinking.
- ⑥ Repeat steps ① to ⑤ to program other channel comments, if desired.



## ■ Microphone lock function

The microphone lock function electrically locks **[▲]/[▼]** and **[HI/LO]** keys on the supplied microphone. This prevents accidental channel changes and function access.

- ➔ While pushing **[HI/LO]** on the microphone, turn power ON to toggle the lock function ON and OFF.

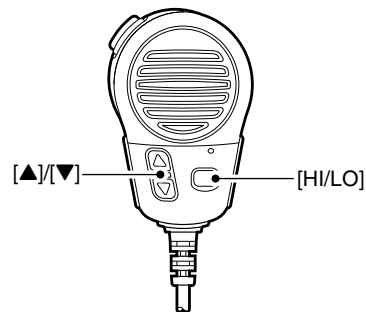

## ■ Display backlighting

The function display and keys can be backlit for better visibility under low light conditions.

- ➔ While pushing **[SCAN•TAG]**, push **[▲]** or **[▼]** to adjust the brightness of the LCD and key backlight.
  - The backlight is selectable in 3 levels and OFF.



## ■ Description

Dualwatch monitors Channel 16 while you are receiving another channel; Tri-watch monitors Channel 16 and the call channel while receiving another channel.

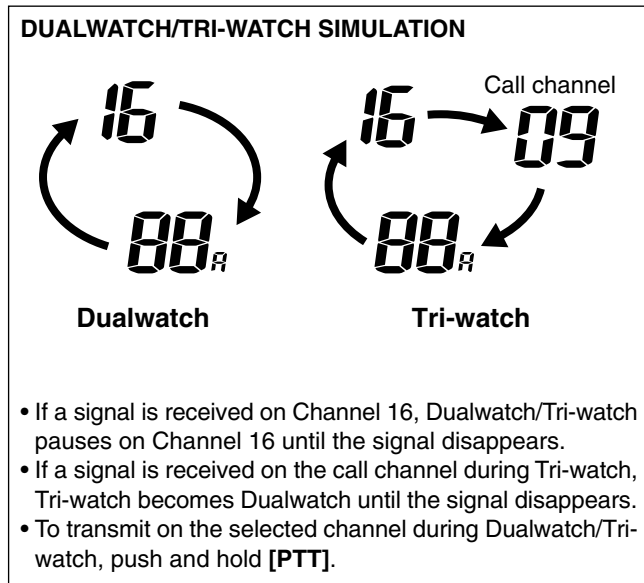

## ■ Operation

- ① Select Dualwatch or Tri-watch in Set mode. (p. 29)
- ② Select the desired operating channel.
- ③ Push **[CH/WX•DUAL]** for 1 sec. to start Dualwatch or Tri-watch.
  - “TW” blinks during Dualwatch; “TW” blinks during Tri-watch.
  - A beep tone sounds when a signal is received on Channel 16.
- ④ To cancel Dualwatch/Tri-watch, push **[CH/WX•DUAL]** again.

**[Example]:** Operating Tri-watch on INT Channel 25

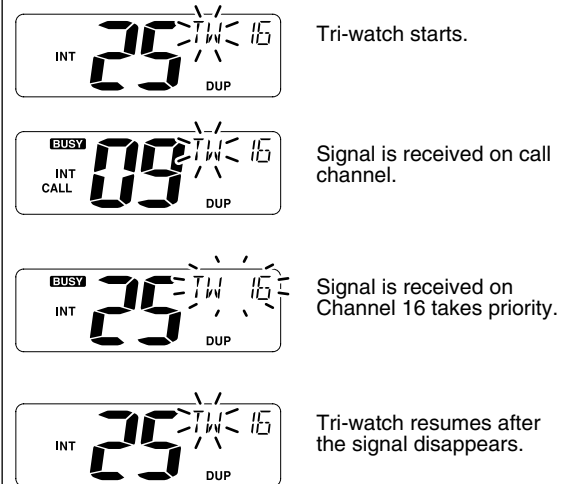

## ■ Scan types

Scanning is an efficient way to locate signals quickly over a wide frequency range. The transceiver has Priority scan and Normal scan.

When the Weather alert function is in use, the selected weather channel is checked while scanning. (p. 29)

### PRIORITY SCAN

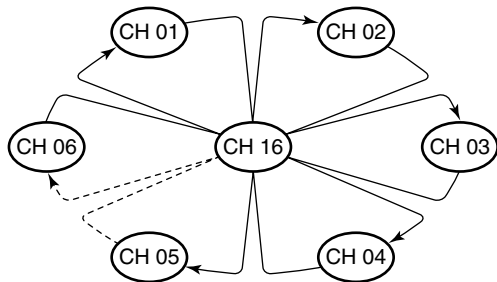

Priority scan searches through all tag channels in sequence while monitoring Channel 16. When a signal is detected on Channel 16, scan pauses until the signal disappears; when a signal is detected on a channel other than Channel 16, scan becomes Dualwatch until the signal disappears.

Set the tag channels (scanned channel) before scanning. Clear the tag channels which inconveniently stop scanning, such as those for digital communication use.

/// Choose Priority or Normal scan in Set mode. (p. 29)

### NORMAL SCAN

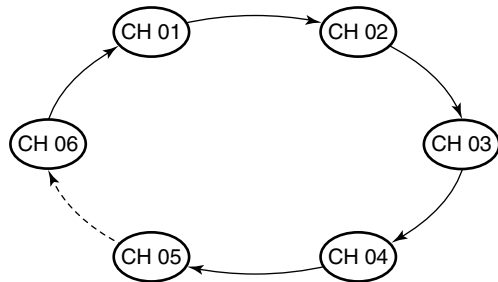

Normal scan, like Priority scan, searches through all tag channels in sequence. However, unlike priority scan, Channel 16 is not checked unless Channel 16 is set as a tag channel.

## ■ Setting tag channels

For more efficient scanning, add desired channels as tag channels or clear the tag for unwanted channels.

Channels are not tagged will be skipped during scanning. Tag channels can be assigned to each channel group (USA, INT, CAN) independently.

- ① Select the desired channel group (USA, INT, CAN) by pushing both [▲] and [▼].
- ② Select the desired channel to set as a tag channel.
- ③ Push [SCAN•TAG] for 1 sec. to be set the displayed channel as a tag channel.
  - “TAG” appears in the display.
- ④ To cancel the tag channel setting, push [SCAN•TAG] for 1 sec.
  - “TAG” disappears.

### ✓ Clearing (or setting) all tagged channels

While pushing [HI/LO] on the microphone, push [SCAN•TAG] for 3 sec. (until a long beep changes to 2 short beeps) to clear all tag channels in the channel group.

- Repeat above procedure to set all tag channels.

## ■ Starting a scan

Set scan type (Priority or Normal) and scan resume timer in advance, using Set mode. (p. 29)

- ① Set tag channels as described at left.
- ② Make sure the squelch is closed to start a scan.
- ③ Select the channel group (USA, CAN, INT) by pushing both [▲] and [▼] on the transceiver, if desired.
- ④ Push [SCAN•TAG] to start Priority or Normal scan.
  - “SC 16” or “SCAN” appears at the channel comment indicator.
  - When a signal is detected, scan pauses until the signal disappears or resumes after pausing 5 sec. according to Set mode setting. (Channel 16 is still monitored during Priority scan.)
  - Push [▲] or [▼] to check the scanning tag channels, to change the scanning direction or resume the scan manually.
  - “16” blinks at the channel comment indicator and a beep tone sounds when a signal is received on Channel 16 during Priority scan.
- ⑤ To stop the scan, push [SCAN•TAG].

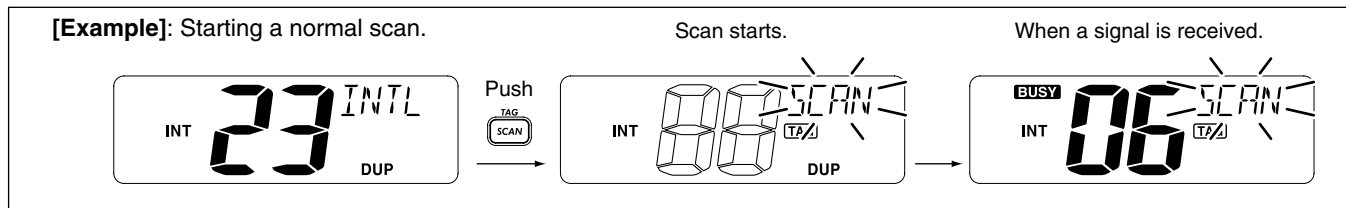

## ■ MMSI code programming

The 9-digit MMSI (Maritime Mobile Service Identity: DSC self ID) code can be programmed at power ON.

▨ This function is not available when the MMSI code has been programmed by the dealer. This code programming can be performed only twice.

- ① Turn power OFF.
- ② While pushing **[DSC•POS]**, turn power ON to enter MMSI code programming condition.
- ③ After the display appears, release **[DSC•POS]**.
  - A cursor starts blinking.

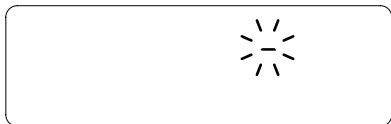

- ④ Edit the specified MMSI code by pushing **[▲]** or **[▼]**.
  - Push **[16•9]** or **[CH/WX•DUAL]** to move the cursor forward or backward, respectively.
- ⑤ Input 9-digit code, then push **[DSC•POS]** to set the code.
  - Returns to the normal operation.

## ■ MMSI code check

The 9-digit MMSI (DSC self ID) code can be checked.

- ① Push **[DSC•POS]** to enter the DSC menu.
- ② Push **[▲]** or **[▼]** to select “MMSI” and push **[DSC•POS]**.

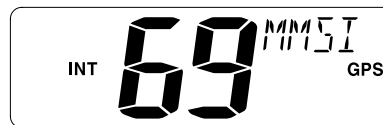

- ③ Check the 9-digit MMSI (DSC self ID) code.
  - The MMSI code is displayed at the channel comment indicator.



MMSI (DSC self ID) code

- ④ Push **[DSC•POS]** to exit the DSC menu.

## ■ DSC individual ID

A total of 30 DSC address IDs (9-digit) can be programmed and named with up to 5 characters.

### ◇ Programming Address ID/Group ID

- ① Push [**DSC•POS**] to enter the DSC menu.
- ② Push [**▲**] or [**▼**] to select “ADDRESS,” and push [**DSC•POS**].

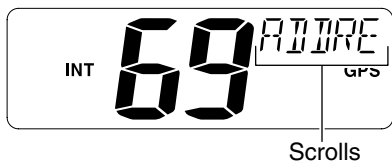

- ③ Push [**▲**] or [**▼**] to select “ADD,” and push [**DSC•POS**].



- ④ Push [**▲**] or [**▼**] to input 9-digit of the appropriate Individual/Group ID.
  - Push [**16•9**] or [**CH/WX•DUAL**] to move the cursor forward or backward, respectively.
  - Push [**SCAN•TAG**] to cancel and exit the condition.

1st digit '0' is fixed for a group ID. Thus an address ID input cannot start with '0.' When you input 1st digit '0' and other 8 digits, the ID is automatically registered as a group ID.



- ⑤ After inputting 9-digit ID, push [**DSC•POS**] to input 5 characters ID name using [**▲**] or [**▼**].
  - Push [**16•9**] or [**CH/WX•DUAL**] to move the cursor forward or backward, respectively.
  - Push [**SCAN•TAG**] to cancel and exit the condition.



- ⑥ Push [**DSC•POS**] to program and exit the DSC menu.

## 6 DSC OPERATION

### ◇ Deleting Address ID/Group ID

- ① Push [**DSC•POS**] to enter the DSC menu.
- ② Push [**▲**] or [**▼**] to select “ADDRESS” and push [**DSC•POS**].



- ③ Push [**▲**] or [**▼**] to select “DEL”, then push [**DSC•POS**].
  - When no address ID is programmed, “NO ID” is displayed.



- ④ Push [**▲**] or [**▼**] to select the desired ID name for deleting and push [**DSC•POS**].
  - “READY” appears.



- ⑤ Push [**DSC•POS**] to delete the address ID and exit the DSC menu.

### ■ Position indication

When a GPS receiver (NMEA0183 ver. 2.0 or 3.01) is connected, the transceiver indicates the current position data in seconds of accuracy.

An NMEA0183 ver. 2.0 or 3.01 (sentence formatters RMC, GGA, GNS, GLL) compatible GPS receiver is required. Ask your dealer about suitable GPS receivers.

- Push [**DSC•POS**] for 1 sec. to display the current position.
  - ‘Latitude’ and ‘Longitude’ scroll in sequence at the channel comment indicator.
  - “NO POSITION” scrolls when no GPS is connected.

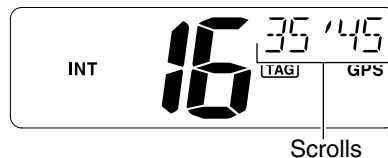

- ▨ • When connecting GPS receiver is compatible with several sentence formatters, the order of input precedence is ‘RMC,’ ‘GGA,’ ‘GNS’ and ‘GLL.’
- ▨ • “GPS” blinks when the GPS data is invalid.

## ■ Distress call

A Distress call should be transmitted, if in the opinion of the Master, the ship or a person is in distress and requires immediate assistance.

**NEVER USE THE DISTRESS CALL WHEN YOUR SHIP OR A PERSON IS NOT IN AN EMERGENCY. A DISTRESS CALL CAN BE USED ONLY WHEN IMMEDIATE HELP IS NEEDED.**

- ① Confirm no Distress call is being received.
- ② While lifting up the key cover, push **[DISTRESS]** for 5 sec. to transmit the Distress call.
  - Emergency channel (Ch 70) is automatically selected and the Distress call is transmitted.



- ③ After transmitting the call, the transceiver waits for an acknowledgment call on Ch70.
  - The Distress call is automatically transmitted every 3.5 to 4.5 minutes.
  - “*DSC REPEAT*” scrolls at the channel comment indicator.

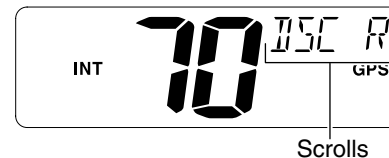

- ④ After receiving the acknowledgment, reply using the microphone.
  - “*REV DISTRESS ACK*” scrolls at the channel comment indicator.

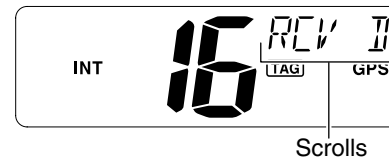

- A distress alert contains;
  - Kinds of distress: Undesignated distress
  - Position data : Latest GPS position data held for 23.5 hrs. or until the power is turned OFF.
- The Distress call is repeated every 3.5–4.5 min., until receiving an ‘acknowledgement.’
- Push **[DISTRESS]** to transmit a renewed Distress call, if desired.
- Push any key except **[DISTRESS]** to cancel the ‘Call repeat’ mode.

## ■ Transmitting DSC calls

### ◇ Transmitting Individual call

The Individual call function allows you to transmit a DSC signal to a specific ship only.

- Push **[DSC•POS]** to enter the DSC menu.
  - “INDIVIDUAL” scrolls at the channel comment indicator.



- Push **[DSC•POS]** and select the desired pre-programmed individual address using **[▲]** or **[▼]**, then push **[DSC•POS]**.
  - The ID code for the individual call must be set in advance. (p. 15)



- Push **[▲]** or **[▼]** to specify the desired intership channel, and push **[DSC•POS]**.
  - Channel 70 is selected and “READY” appears.

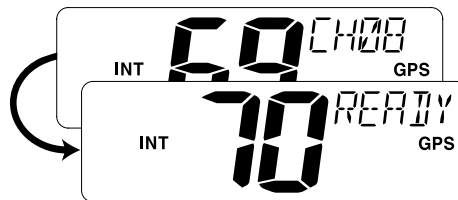

- Push **[DSC•POS]** to transmit the Individual call.
  - If Channel 70 is busy, the transceiver stands by until the channel becomes clear.
  - Routine category only is available.



Push **[DSC•POS]** to transmit DSC call.



When Ch 70 is busy.



- ⑤ After transmitting the Individual call, stands by on Channel 70 until an acknowledgement is received.
  - “WAIT ACK” scrolls at the channel comment indicator.

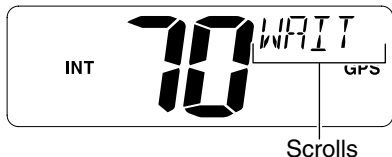

- ⑥ When the acknowledgement ('able to comply') is received, the specified channel (in step ③) is selected with beeps automatically. Or, when the acknowledgement ('unable to comply') is received, the display returns to the operated channel (before enter the DSC menu) with beeps.
  - “REV ABLE ACK” or “REV UNABLE ACK” scrolls at the channel comment indicator.



- ⑦ Push and hold [PTT] to communicate your message to the responding ship.

◇ **Transmitting Individual acknowledgement**

Transmit an acknowledgement ('able to comply' or 'unable to comply') when an Individual call for you is received.

- ① Push [DSC•POS] to enter the DSC menu.
- ② Push [▲] or [▼] to select “INTV ACK” and push [DSC•POS].
  - “INTV ACK” item appears after an Individual call is received.
  - “INTV ACK” item disappears if another call is received after the Individual call.
  - The Individual acknowledgement can be transmitted to the last received individual call only.



- ③ Push [▲] or [▼] to select the acknowledgement “ABLE” or “UNABLE.”



## 6 DSC OPERATION

- ④ Push [DSC•POS] to enter selected Individual call acknowledgement.

- “READY” appears at the channel comment indicator.



- ⑤ Push [DSC•POS] to transmit the acknowledgement to the station.



- ⑥ After the Individual acknowledgement has been transmitted, the display changes to the channel specified by the calling station automatically when “ABLE” is selected.



### ◇ Transmitting Group call

The Group call function allows you to transmit a DSC signal to a specific group only.

- ① Push [DSC•POS] to enter the DSC menu.
- ② Push [▲] or [▼] to select “GROUP,” and push [DSC•POS].



- ③ Push [▲] or [▼] to select the desired pre-programmed group address, and push [DSC•POS].
  - The ID code for the group call must be set in advance. (p. 15)



- ④ Push [▲] or [▼] to select the desired intership channel, and push [DSC•POS].
- Channel 70 is selected and “READY” appears.

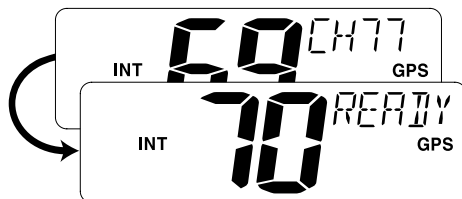

- ⑦ Push and hold [PTT] to communicate your message to the responding ship.

- ⑤ Push [DSC•POS] to transmit the Group call.
- If Channel 70 is busy, the transceiver stands by until the channel becomes clear.
  - Routine category only is available.



- ⑥ After the Group call has been transmitted, the display changes to the previously selected channel.

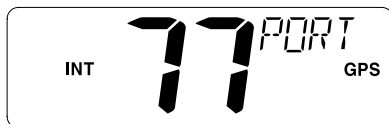

## 6 DSC OPERATION

### ◇ Transmitting All Ships call

Large ships use Channel 70 as their 'listening channel.'

When you want to announce a message to these ships, use the 'All Ships call' function.

- ① Push **[DSC•POS]** to enter the DSC menu.
- ② Push **[▲]** or **[▼]** to select "ALL SHIPS."



- ③ Push **[DSC•POS]** to enter the standby condition for All Ships call.
  - Channel 70 is selected and "READY" appears.



- ④ Push **[DSC•POS]** to transmit the All Ships call.
  - Routine category only is available.



- ⑤ After the All Ships call has been transmitted, the display changes to Channel 16 automatically.

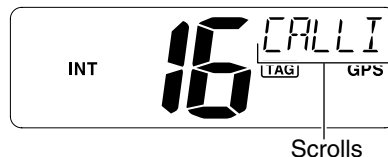

◇ **Transmitting Position Request call**

Transmit a Position Request call when you want to know a specified ship's current position, etc.

- ① Push [DSC•POS] to enter the DSC menu.
- ② Push [▲] or [▼] to select "POS REQUEST," and push [DSC•POS].



- ③ Push [▲] or [▼] to select the desired pre-programmed individual address.
  - The ID code for position request must be set in advance. (p. 15)



- ④ Push [DSC•POS] to enter the standby condition for Position Request call.
  - Channel 70 is selected and "READY" appears.



- ⑤ Push [DSC•POS] to transmit the Position Request call.



- ⑥ After the Position Request call has been transmitted, the following indication is displayed.
  - "WAIT ACK" scrolls at the channel comment indicator.



- ⑦ Push any key to exit the condition and return to the normal operation.

## 6 DSC OPERATION

### ◇ Transmitting Position Report call

Transmit a Position Report call when you want to announce your own position to a specific ship and to get an answer, etc.

- ① Push **[DSC•POS]** to enter the DSC menu.
- ② Push **[▲]** or **[▼]** to select “*POS REPORT*,” and push **[DSC•POS]**.



- ③ Push **[▲]** or **[▼]** to select the desired pre-programmed individual address.
  - The ID code for the individual call can be set in advance. (p. 15)



- ④ Push **[DSC•POS]** to enter the standby condition for Position Report call.
  - Channel 70 is selected and “*READY*” appears.



- ⑤ Push **[DSC•POS]** to transmit the Position Report call.



- ⑥ After the Position Report call has been transmitted, stand by on Channel 70 until an acknowledgement is received.
  - “*WAIT ACK*” scrolls at the channel comment indicator.



- ⑦ Push any key to exit the condition and return to the normal operation.

## ■ Receiving DSC calls

### ◇ Receiving a Distress call

While monitoring Channel 70 and a Distress call is received:

- ➔ The emergency alarm sounds for 2 minutes.
  - Push any key to stop the alarm.
- ➔ “DSC” appears and “*REV DISTRESS*” scrolls at the channel comment indicator, then Channel 16 is automatically selected.
- ➔ Continue monitoring Channel 16 as a coast station may require assistance.



### ◇ Receiving a Distress acknowledgement

While monitoring Channel 70 and a Distress acknowledgement to other ship is received:

- ➔ The emergency alarm sounds for 2 minutes.
  - Push any key to stop the alarm.
- ➔ “*REV DISTRESS ACK*” scrolls at the channel comment indicator, then Channel 16 is automatically selected.



### ◇ Receiving a Distress Relay call

While monitoring Channel 70 and a Distress Relay acknowledgement is received:

- ➔ The emergency alarm sounds for 2 minutes.
  - Push any key to stop the alarm.
- ➔ “*REV RELAY*” scrolls at the channel comment indicator, then Channel 16 is automatically selected.

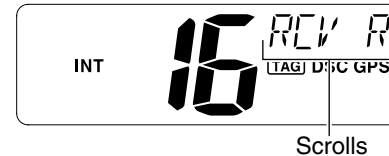

### ◇ Receiving an Individual call

While monitoring Channel 70 and an Individual call is received:

- ➔ The emergency alarm or beeps sound depending on the received category.
- ➔ “*REV INDIVIDUAL*” scrolls at the channel comment indicator.



- ➔ Push [**DSC•POS**] to change to the channel specified by the calling station for voice communication; push any other key to ignore the Individual call.

## 6 DSC OPERATION

### ◇ Receiving a Group call

While monitoring Channel 70 and a Group call is received:

- The emergency alarm or beeps sound depending on the received category.
- “REV GROUP” scrolls at the channel comment indicator.

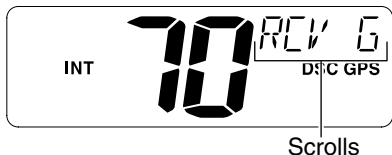

- Push [**DSC•POS**] to change to the channel specified by the calling station for voice communication; push any other key to ignore the Group call.

### ◇ Receiving an All Ships call

While monitoring Channel 70 and an All Ships call is received:

- The emergency alarm sounds when the category is ‘Distress’ or ‘Urgency’; 2 beeps sound for other categories.
- “REV ALL SHIPS” scrolls at the channel comment indicator.



- Push [**DSC•POS**] to change to the channel specified by the calling station for voice communication; push any other key to ignore the All Ships call.
- Monitor the channel for an announcement from the calling vessel.

### ◇ Receiving a Geographical Area call

While monitoring Channel 70 and a Geographical Area call (for the area you are in) is received:

- The emergency alarm or beeps sound depending on the received category.
- “REV GEOGRAPHICAL” scrolls at the channel comment indicator.



- Push [**DSC•POS**] to change to the channel specified by the calling station for voice communication; push any other key to ignore the Geographical Area call.
- Monitor the selected channel for an announcement from the calling station.

▨ When no GPS receiver is connected or if there is a problem with the connected receiver, all Geographical Area calls are received, regardless of your position.



### ◇ Receiving a Position Request call

While monitoring Channel 70 and a Position Request call is received:

- ➔ “REV POS REQUEST” scrolls at the channel comment indicator.

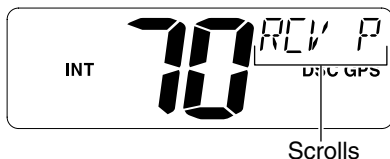

- ➔ Push [**DSC•POS**] to reply to the Position Request call; push any other key to ignore the Position Request call.

### ◇ Receiving a Position Request Reply call

While monitoring Channel 70 and a Position Request Reply call is received:

- ➔ “DSC” and “POS REPLY” appear in the display.
  - The ‘Latitude’ and ‘Longitude’ from the called station is displayed and scrolled automatically in order of Latitude co-ordinates and then Longitude co-ordinates.

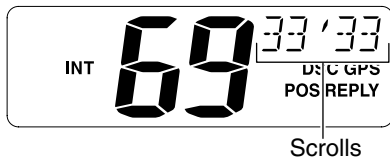

### ◇ Receiving a Position Report call

While monitoring Channel 70 and a Position Report call is received:

- ➔ “REV POS REPORT” scrolls at the channel comment indicator.



- ➔ Push [**DSC•POS**] to reply to the Position Report call; push any other key to ignore the Position Report call.

### ◇ Receiving a Position Report Reply call

While monitoring Channel 70 and a Position Report Reply call is received:

- ➔ “DSC” and “POS REPLY” appear in the display.
  - The ‘Latitude’ and ‘Longitude’ you have sent is displayed and scrolled automatically in order of Latitude co-ordinates and then Longitude co-ordinates.



## ■ Set mode programming

Set mode is used to change the conditions of the transceiver's functions: scan type (Normal or Priority,) scan resume timer, Weather alert, Dual/Tri-watch, DSC watch, transceiver's beep tone and Auto ACK.

/// Available functions may differ depending on dealer setting.

### ◇ Set mode operation

- ① Turn power OFF.
- ② While pushing [16•9], turn power ON to enter Set mode.
  - "SCAN" appears on channel comment indicator.
- ③ After the display appears, release [16•9].
- ④ Push [16•9] to select the desired item, if necessary.
- ⑤ Push [▲] or [▼] to select the desired condition of the item.
- ⑥ Turn power OFF, then ON again to exit Set mode.

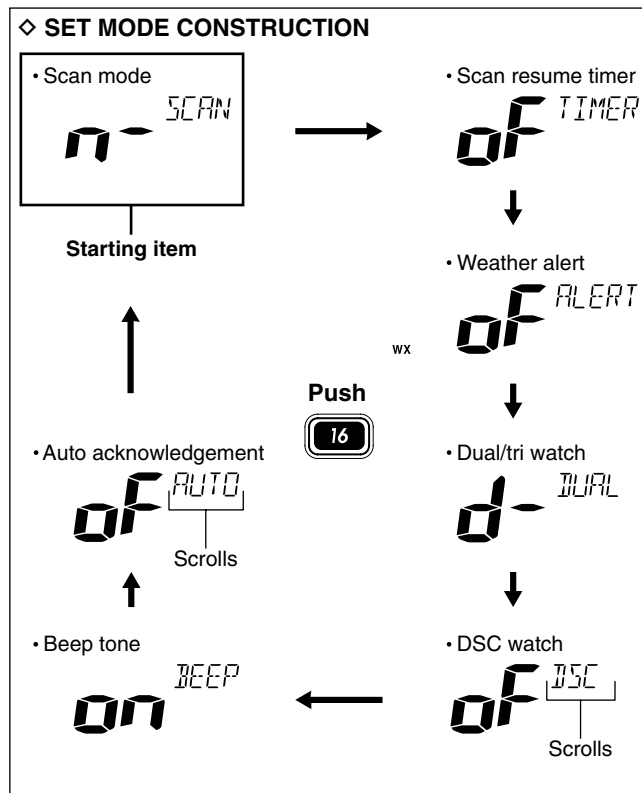

## ■ SET mode items

### ◇ Scan type

The transceiver has 2 scan types: Normal scan and Priority scan. Normal scan searches all tag channels in the selected channel group. Priority scan searches all tag channels in sequence while monitoring Channel 16.

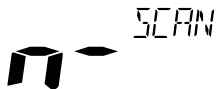

Normal scan (default)

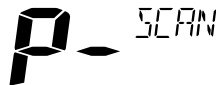

Priority scan

### ◇ Scan resume timer

The scan resume timer can be selected as a pause (OFF) or timer scan (ON). When OFF is selected, the scan pauses until the signal disappears. When ON is selected, the scan pauses 5 sec. and resumes even if a signal has been received on any other channel than Channel 16.



Scan timer OFF (default)



Scan timer ON

### ◇ Weather alert

A NOAA broadcast station transmits a weather alert tone before important weather information. When the weather alert function is turned ON, the transceiver detects the alert, then the “WX ALT” indicator blinks until the transceiver is operated. The previously selected (used) weather channel is checked any time during standby or while scanning.

- “WX ALT” appears instead of “WX” indication when the function is set ON.



Weather alert OFF (default)



Weather alert ON

### ◇ Dual/Tri-watch

This item can be selected as Dualwatch or Tri-watch. (p. 11)



Dualwatch (default)



Tri-watch

## 7 SET MODE

### ◆ DSC watch

DSC watch monitors Channel 70 while you are receiving another channel.

If a distress signal is received on Channel 70, the transceiver monitors Channel 16 and 70 alternately until the distress signal disappears. If a signal is received on another channel, DSC watch pauses until the signal disappears.

/// This function may not be available for some channel groups depending on dealer setting.

- “DSC WATCH” scrolls at the channel comment indicator.



DSC watch OFF (default)

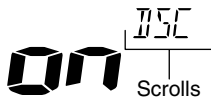

DSC watch ON

### ◆ Beep tone

You can select silent operation by turning beep tones OFF or you can have confirmation beeps sound at the push of a key by turning beep tones ON.



Beep tone ON (default)



Beep tone OFF

### ◆ Automatic acknowledgement

This item sets the Automatic acknowledgement function ON or OFF.

When Position Request or Position Report call is received, transceiver automatically transmits Position Request Reply or Position Report Reply, respectively.

- “AUTO ACK” scrolls at the channel comment indicator.

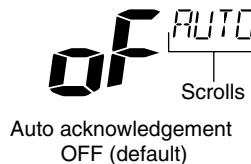

Auto acknowledgement  
OFF (default)

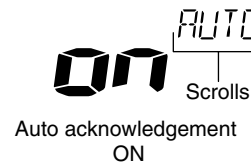

Auto acknowledgement  
ON

## ■ Supplied accessories

The following accessories are supplied:	Qty.
① Mounting bracket .....	1
② DC power cable (OPC-891) .....	1
③ Microphone hanger .....	1
④ Knob bolts for mounting bracket .....	2
⑤ Mounting screws (5 × 20) .....	2
⑥ Mic hanger screws (3 × 16) .....	2
⑦ Flat washers (M5) .....	2
⑧ Spring washers (M5) .....	2
⑨ Warning sticker .....	1

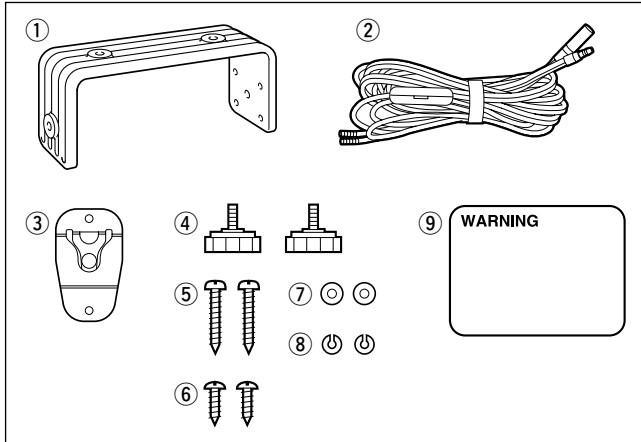

## ■ Antenna

A key element in the performance of any communication system is an antenna. Ask your dealer about antennas and the best place to mount them.

## ■ Fuse replacement

One fuse is installed in the supplied DC power cable. If a fuse blows or the transceiver stops functioning, track down the source of the problem, if possible, and replace the damaged fuse with a new, rated one.

## ■ Cleaning

If the transceiver becomes dusty or dirty, wipe it clean with a soft, dry cloth.



**AVOID** the use of solvents such as benzene or alcohol, as they may damage transceiver surfaces.

## ■ Connections

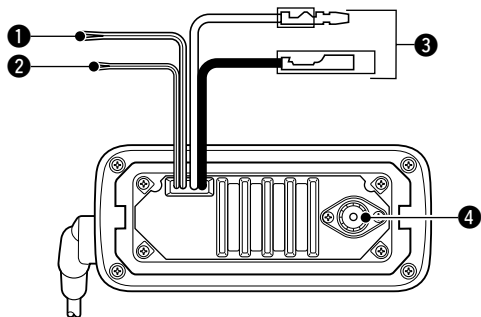

### ❶ GPS RECEIVER LEAD

Connects to a GPS receiver for position indication.

- An NMEA0183 ver. 2.0 or 3.01 (sentence formatters RMC, GGA, GNS, GLL) compatible GPS receiver is required. Ask your dealer about suitable GPS receivers.

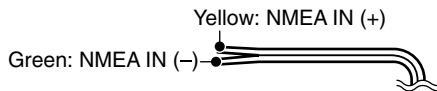

### ❷ EXTERNAL SPEAKER LEAD

Connects to an external speaker.

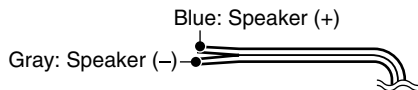

### ❸ DC POWER CONNECTOR

Connects the supplied DC power cable from this connector to an external 12 V battery.

### ❹ ANTENNA CONNECTOR

Connects a marine VHF antenna with a PL-259 connector to the transceiver.

**CAUTION:** Transmitting without an antenna may damage the transceiver.

**CAUTION:** After connecting the DC power cable, GPS receiver lead and external speaker lead, cover the connector and leads with an adhesive tape as shown below, to prevent water seeping into the transceiver.

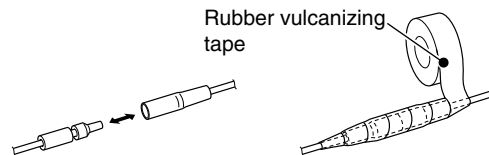

## ■ Mounting the transceiver

### ◆ Using the supplied mounting bracket

The universal mounting bracket supplied with your transceiver allows overhead or dashboard mounting.

- Mount the transceiver securely with the 2 supplied screws (5 × 20) to a surface which is more than 10 mm thick and can support more than 5 kg.
- Mount the transceiver so that the face of the transceiver is at 90° to your line of sight when operating it.

**CAUTION:** KEEP the transceiver and microphone at least 1 meter away from your vessel's magnetic navigation compass.

**NOTE:** Check the installation angle; the function display may not be easy-to-read at some angles.

#### EXAMPLE

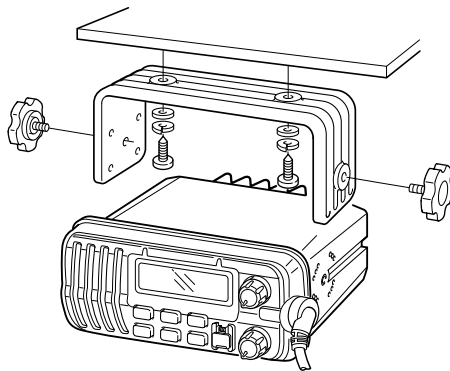

## ■ Optional MB-92 attachment

An optional MB-92 DUST COVER is available for attaching the transceiver's front panel to prevent the keys and knobs getting wet when the transceiver is not used.

- ➔ Attach the optional MB-92 DUST COVER to the transceiver as shown below.

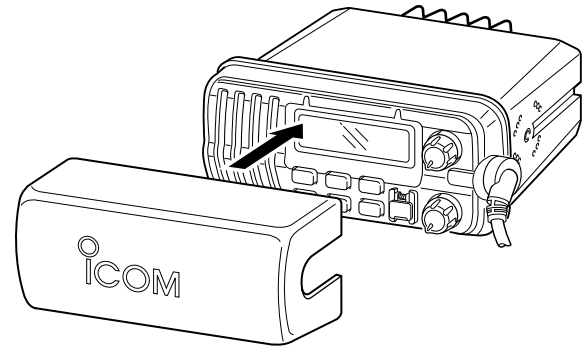

## 8 CONNECTIONS AND MAINTENANCE

### ■ Optional MB-69 installation

An optional MB-69 FLUSH MOUNT is available for mounting the transceiver to a flat surface such as an instrument panel.

**CAUTION:** KEEP the transceiver and microphone at least 1 meter away from your vessel's magnetic navigation compass.

- ① Using the template on p. 39, carefully cut a hole into the instrument panel (or wherever you plan to mount the transceiver.)
- ② Slide the transceiver through the hole as shown below.

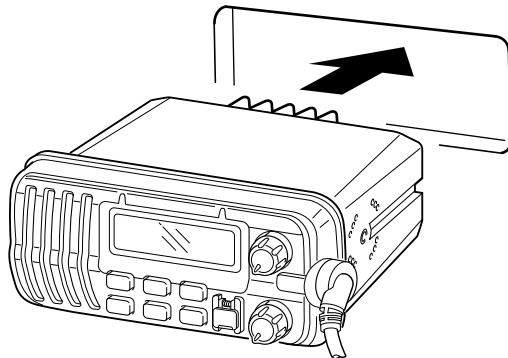

- ③ Attach the clamps on either side of the transceiver with 2 supplied bolts (5 × 8 mm).
  - Make sure that the clamps align parallel to the transceiver body.

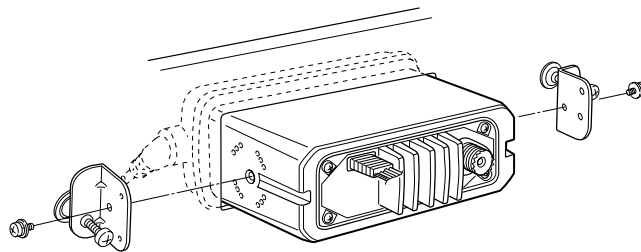

- ④ Tighten the end bolts on the clamps (rotate clockwise) so that the clamps press firmly against the inside of the instrument control panel.
- ⑤ Tighten the locking nuts (rotate counterclockwise) so that the transceiver is securely mounted in position as below.
- ⑥ Connect the antenna and power cable, then return the instrument control panel to its original place.

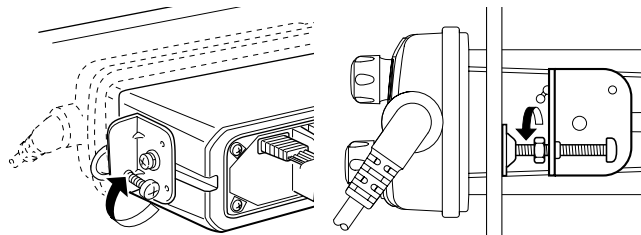



PROBLEM	POSSIBLE CAUSE	SOLUTION	REF.
The transceiver does not turn ON.	<ul style="list-style-type: none"> <li>• Bad connection to the power supply.</li> </ul>	<ul style="list-style-type: none"> <li>• Check the connection to the transceiver.</li> </ul>	p. 32
No sound from speaker.	<ul style="list-style-type: none"> <li>• Squelch level is too high.</li> <li>• Volume level is too low.</li> <li>• Speaker has been exposed to water.</li> </ul>	<ul style="list-style-type: none"> <li>• Set squelch to the threshold point.</li> <li>• Set <b>[VOL]</b> to a suitable level.</li> <li>• Drain water from the speaker.</li> </ul>	<p>p. 8</p> <p>p. 8</p> <p>—</p>
Transmitting is impossible, or high power can not be selected.	<ul style="list-style-type: none"> <li>• Some channels are for low power or receive only.</li> <li>• The output power is set to low.</li> </ul>	<ul style="list-style-type: none"> <li>• Change channels.</li> <li>• Push <b>[HI/LO]</b> on the microphone to select high power.</li> </ul>	<p>pgs. 6, 7, 36</p> <p>p. 8</p>
Scan does not start.	<ul style="list-style-type: none"> <li>• “TAG” channel is not programmed.</li> </ul>	<ul style="list-style-type: none"> <li>• Set the desired channels as “TAG” channels.</li> </ul>	p. 13
No beeps.	<ul style="list-style-type: none"> <li>• Beep tones are turned OFF.</li> <li>• The squelch is open.</li> </ul>	<ul style="list-style-type: none"> <li>• Turn the beep tone ON in Set mode.</li> <li>• Set squelch to the threshold point.</li> </ul>	<p>p. 30</p> <p>p. 8</p>
Distress call cannot be transmitted.	<ul style="list-style-type: none"> <li>• MMSI (DSC self ID) code is not programmed.</li> </ul>	<ul style="list-style-type: none"> <li>• Program the MMSI (DSC self ID) code.</li> </ul>	p. 14

# 10 CHANNEL LIST

Channel number			Frequency (MHz)	
USA	INT	CAN	Transmit	Receive
	01	01	156.050	160.650
01A			156.050	156.050
	02	02	156.100	160.700
	03	03	156.150	160.750
03A			156.150	156.150
	04		156.200	160.800
		04A	156.200	156.200
	05		156.250	160.850
05A		05A	156.250	156.250
06	06	06	156.300	156.300
	07		156.350	160.950
07A		07A	156.350	156.350
08	08	08	156.400	156.400
09	09	09	156.450	156.450
10	10	10	156.500	156.500
11	11	11	156.550	156.550
12	12	12	156.600	156.600
13 <sup>2</sup>	13	13 <sup>1</sup>	156.650	156.650
14	14	14	156.700	156.700
15 <sup>2</sup>	15 <sup>1</sup>	15 <sup>1</sup>	156.750	156.750
16	16	16	156.800	156.800
17 <sup>1</sup>	17	17 <sup>1</sup>	156.850	156.850
	18		156.900	161.500
18A		18A	156.900	156.900
	19		156.950	161.550

Channel number			Frequency (MHz)	
USA	INT	CAN	Transmit	Receive
19A		19A	156.950	156.950
20	20	20 <sup>1</sup>	157.000	161.600
20A			157.000	157.000
	21	21	157.050	161.650
21A		21A	157.050	157.050
		21b	Rx only	161.650
	22		157.100	161.700
22A		22A	157.100	157.100
	23	23	157.150	161.750
23A			157.150	157.150
24	24	24	157.200	161.800
25	25	25	157.250	161.850
		25b	Rx only	161.850
26	26	26	157.300	161.900
27	27	27	157.350	161.950
28	28	28	157.400	162.000
		28b	Rx only	162.000
	60	60	156.025	160.625
	61		156.075	160.675
61A		61A	156.075	156.075
	62		156.125	160.725
		62A	156.125	156.125
	63		156.175	160.775
63A			156.175	156.175
	64	64	156.225	160.825

Channel number			Frequency (MHz)	
USA	INT	CAN	Transmit	Receive
64A		64A	156.225	160.825
	65		156.275	160.875
65A	65A	65A	156.275	156.275
	66		156.325	160.925
66A	66A	66A <sup>1</sup>	156.325	156.325
67 <sup>2</sup>	67	67	156.375	156.375
68	68	68	156.425	156.425
69	69	69	156.475	156.475
70 <sup>3</sup>	70 <sup>3</sup>	70 <sup>3</sup>	156.525	156.525
71	71	71	156.575	156.575
72	72	72	156.625	156.625
73	73	73	156.675	156.675
74	74	74	156.725	156.725
77 <sup>1</sup>	77	77 <sup>1</sup>	156.875	156.875
	78		156.925	161.525
78A		78A	156.925	156.925
	79		156.975	161.575
79A		79A	156.975	156.975
	80		157.025	161.625
80A		80A	157.025	157.025
	81		157.075	161.675
81A		81A	157.075	157.075
	82		157.125	161.725
82A		82A	157.125	157.125
	83	83	157.175	161.775

Channel number			Frequency (MHz)	
USA	INT	CAN	Transmit	Receive
83A		83A	157.175	157.175
		83b	Rx only	161.775
84	84	84	157.225	161.825
84A			157.225	157.225
85	85	85	157.275	161.875
85A			157.275	157.275
86	86	86	157.325	161.925
86A			157.325	157.325
87	87	87	157.375	161.975
87A			157.375	157.375
88	88	88	157.425	162.025
88A			157.425	157.425
WX channel	Frequency (MHz)			
	Transmit	Receive		
1	RX only		162.550	
2	RX only		162.400	
3	RX only		162.475	
4	RX only		162.425	
5	RX only		162.450	
6	RX only		162.500	
7	RX only		162.525	
8	RX only		161.650	
9	RX only		161.775	
10	RX only		163.275	

<sup>1</sup>Low power only. <sup>2</sup>Momentary high power. <sup>3</sup>DSC operation only

**NOTE:** Simplex channels, 3, 21, 23, 61, 64, 81, 82 and 83 **CANNOT** be lawfully used by the general public in U.S.A. waters.

## ■ Specifications

### ◆ General

- Frequency coverage :  
 Transmit 156.025–157.425 MHz  
 Receive 156.050–163.275 MHz
- Mode : FM (16K0G3E)  
 DSC(16K0G2B)
- Channel spacing : 25 kHz
- Current drain (at 13.8 V) : TX high 5.5 A max.  
 Max. audio 1.5 A max.
- Power supply requirement : 13.8 V DC
- Frequency stability : ±10 ppm  
 (–20°C to +60°C; –4°F to +140°F)
- Dimensions : 153(W) × 67(H) × 132(D) mm  
 (Projections not included) 6 1/32(W) × 2 5/8(H) × 5 3/16(D) in
- Weight : Approx. 825 g ; 1.8 lb

### ◆ Transmitter

- Output power : 25 W and 1 W
- Modulation system : Variable reactance frequency modulation
- Max. frequency deviation : ±5.0 kHz
- Spurious emissions : Less than –70 dB

### ◆ Receiver

- Receive system : Double conversion superheterodyne
- Sensitivity (12 dB SINAD) : 0.22μV (typical)
- Squelch sensitivity : Less than 0.22μV
- Intermodulation rejection ratio : More than 70 dB
- Spurious response rejection ratio: More than 70 dB
- Adjacent channel selectivity : More than 70 dB
- Audio output power : 4.5W (typical) at 10% distortion with a 4 Ω load

**All stated specifications are subject to change without notice or obligation.**

# 11 SPECIFICATIONS

## ■ Dimensions

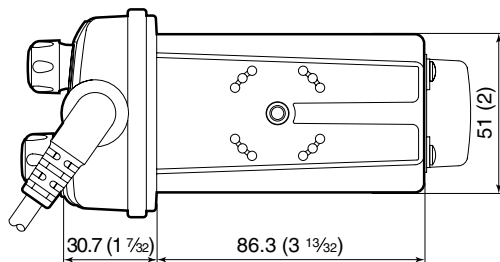
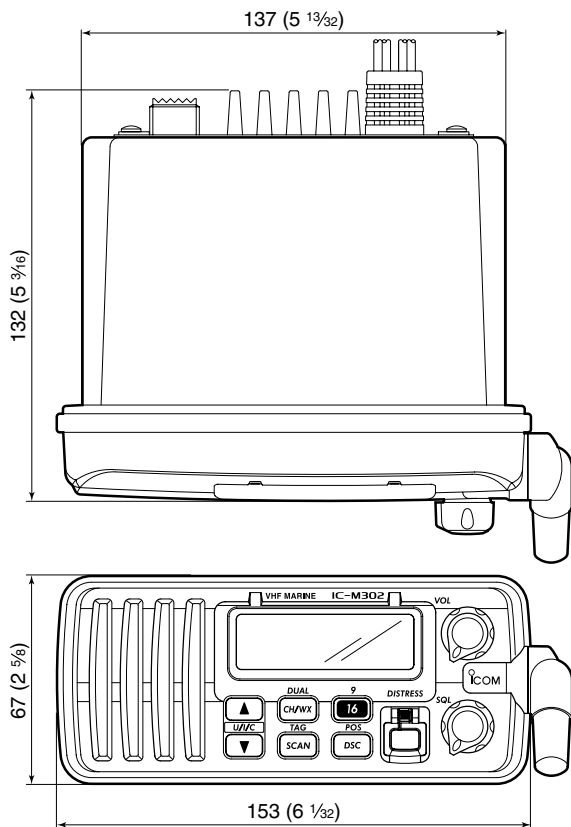

Unit: mm (inch)

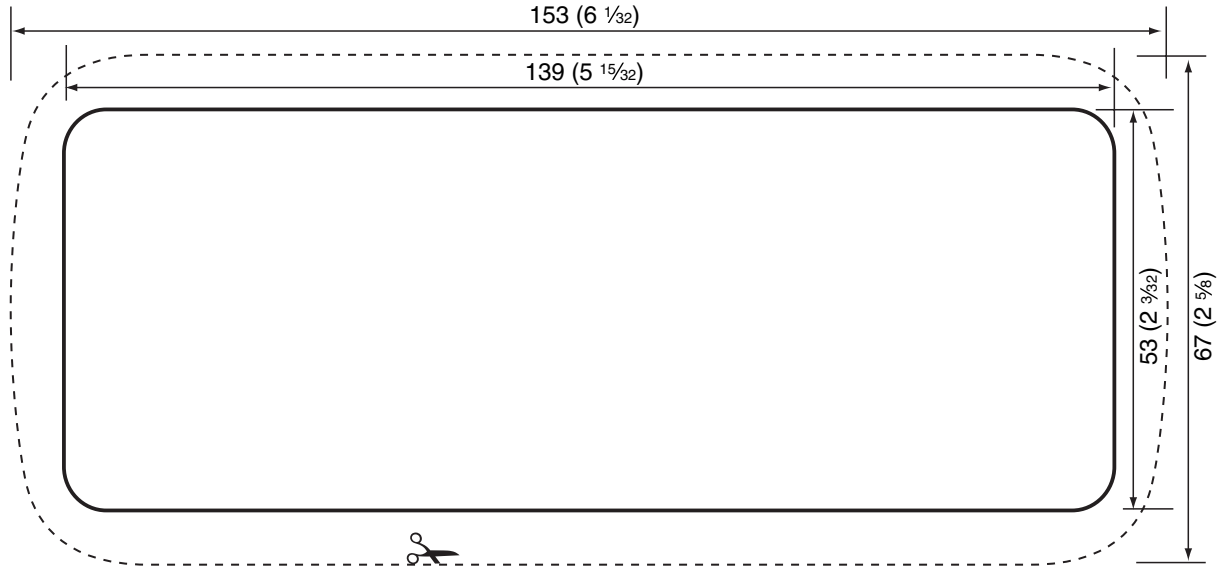

Unit: mm (inch)

Cut here



- **MB-69 FLUSH MOUNT**

For mounting the transceiver to a panel.

- **MB-92 DUST COVER**

For attaching the front panel of the transceiver to protect it when not in use.

**Count on us!**

A-6308D-1US-①  
Printed in Japan  
© 2003 Icom Inc.

**Icom Inc.**  
1-1-32 Kamiminami, Hirano-ku, Osaka 547-0003, Japan